

**verjüngte Spitze**  
(taper tip)

Ø 3,2 mm  
Ø 4,8 mm

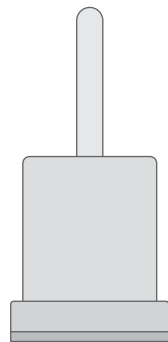

**Starrer Fühler**  
(rigid probe)

**runde Spitze**  
(bullet tip)

Ø 3,2 mm  
Ø 4,8 mm

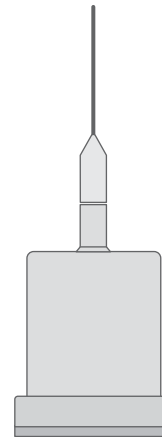

**Nadelspitze**  
(rigid probe + needle tip)

Ø 1,5 mm

## Fühlerlängen

25 mm	(Ø 3,2 mm)	127523-505
38 mm	(Ø 3,2mm)	127523-506
51 mm	(Ø 3,2mm)	127523-501
76 mm	(Ø 3,2mm)	127523-502
102 mm	(Ø 3,2mm)	127523-503
127 mm	(Ø 3,2mm)	127523-504
152 mm	(Ø 4,8mm)	127180-6IS

kundenspez. Länge  
(Ø 3,2mm Ø 4,8mm)

127523-520  
127180-XIS

## Fühlerlängen

25 mm	(Ø 3,2 mm)	127113-505
51 mm	(Ø 4,8mm)	127213-501
76 mm	(Ø 3,2mm)	127113-502
102 mm	(Ø 3,2mm)	127113-503
127 mm	(Ø 3,2mm)	127113-504
191 mm	(Ø 4,8mm)	127213-508

kundenspez. Länge  
(Ø 3,2mm Ø 4,8mm)

127213-520  
127213-503

## Fühlerlängen

25 mm	127678-505
51 mm	127678-501
76 mm	127678-502
102 mm	127678-503
127 mm	127678-504

kundenspez. Länge

127678-520

## MPIII Temperatur

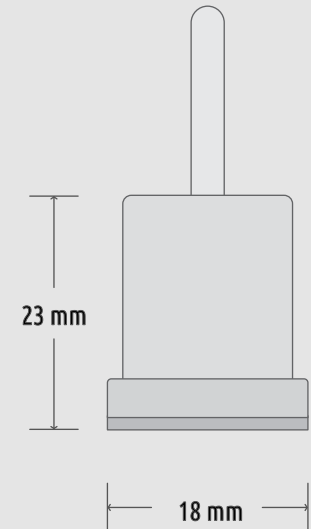

## biegbare Fühler

### Fühlerlängen

250mm 124947-021 & 124947-023  
350mm 124947-031 & 124947-033  
650mm 124947-061 & 124947-063  
kundenspez. Länge  
124947-0X1 & 124947-0X3  
kundenspez. Länge >350mm  
124947-0X1

Durchmesser:  
Ø 2mm: -20°C bis +140°C  
Ø 3,2mm: -20°C bis 400°C

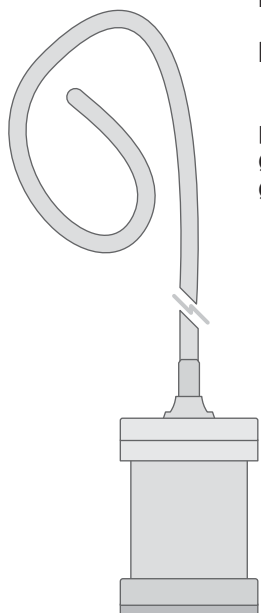

## flexible Fühler (Edelstahl oder Silikon)

### Fühlerlängen

152mm  
305mm  
kundenspez. Länge (Silikon)

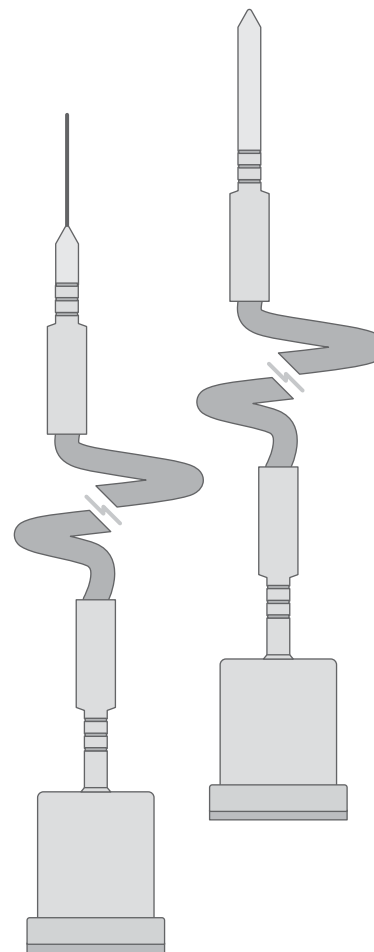

## MPIII Temperatur

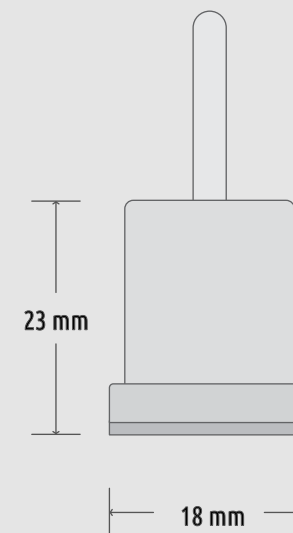

## Dual

2x biegbarer Edelstahlfühler Ø 2mm  
(250mm, 350mm, 650mm)

2x flexibler Edelstahlfühler Ø 1,5mm Nadelspitze  
(305mm, kundenspez. Länge)

2x starre Fühler, verjüngte Spitze Ø 3,2mm

1x starrer Fühler, verjüngte Spitze Ø 3,2mm &  
1x flexibler Edelstahlfühler, verjüngte Spitze Ø 3,2mm oder Ø 1,5mm Nadelspitze

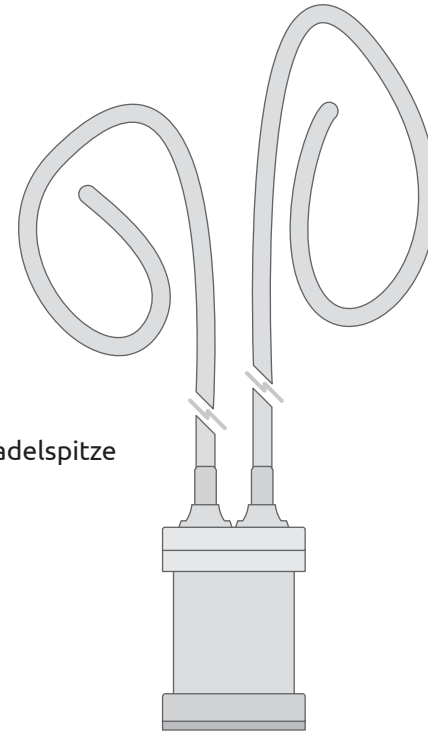
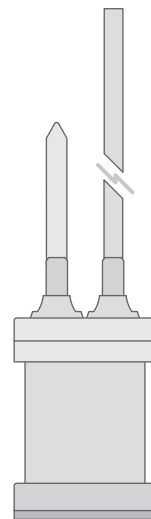
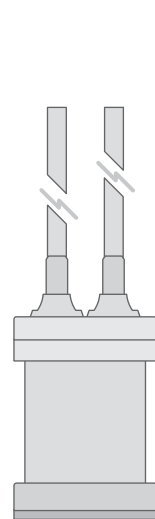
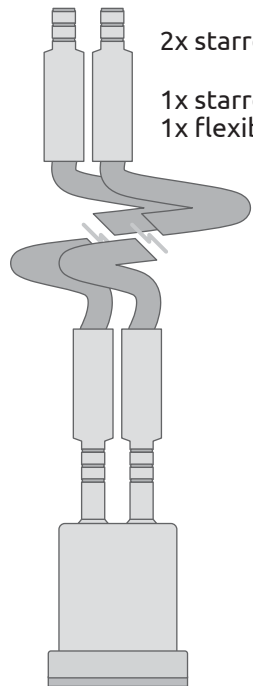

## MPIII Temperatur

